



BC5401 LED Hazardous Area Light T8 (With Emergency Option)

Spec Sheet

Overview

The Tormin BC5401 LED Hazardous Area Light T8 (With Emergency Option) is a highly versatile LED fitting/emergency fitting that can be used in a wide range of internal and exterior hazardous areas, as an alternative or replacement for less efficient and reliable fluorescent light fittings. The rugged design makes the BC5401 ideal for harshest conditions, both outside and indoors.

Features & Benefits

- High efficacy LED light source replaces fluorescent light fittings.
- Suitable for operation in low and high temperature environments.
- Suitable for operation in corrosive environments.
- Choice of ceiling, wall or pole fixing.
- Impact and vibration resistant.
- Option of maintained emergency fitting.
- 5 Year warranty.
- ATEX Zones 1 and 2, 21 and 22, Certified by Eurofins product testing, Italy.

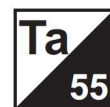
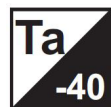

RoHS

Technical Specification

Description: BC5401 LED Hazardous Area Light T8

Recommended Product Location: Hazardous areas

PRODUCT DETAILS	
Ex mark	Ex de op is IIC T5 Gb, Ex op is tb IIIC T95°C Db, IP66
Voltage	90-264 VAC 50/60Hz
IP Rating	IP66
Typical Lumens per watt	100lm/W
Colour Rendering	>0.80
Beam angle	120°
Operating Temperature	-40°C to +55°C
Colour Temperature	5000k (4000k & 6000k available special order)
Power Factor	0.95
Driver	/
Dimension	139X180X110mm(40W)/ 780X180X110(20W)
Warranty	5 Year Repair / Replace Warranty
Cable Entry	M20×1.5, M25×1.5, G3/4", NPT1/2", NPT3/4"
Terminals	Multi core: ≤2.5mm ² Single core: ≤4mm ²
Net Weight	10.7KGS(40w)/ 6.6KGS(20w)

PRODUCT OPTIONS	
Occupancy Sensor	N/A
Light level sensor	N/A
Remote Programmable Sensor	N/A
High borosilicate glass front	Fitted as standard
RGB	N/A
18~43VAC/18~55VDC	N/A
Emergency	20W.10W (With extra emergency box)
Fixed Bracket Mounting	√

Ambient Temperature / Temperature Group

Circuit Watts	TA ≤55°C
20w	T5
40w	T5

Performance Chart

LED POWER	CIRCUIT WATTS	TYPICAL LUMENS
20w	20w	2000lm
40w	40w	4000lm

Diagram of BC5401

Derrick mounting

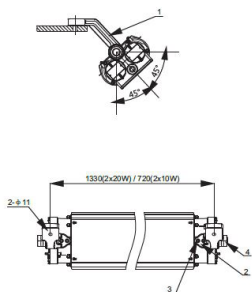

Pole mounting

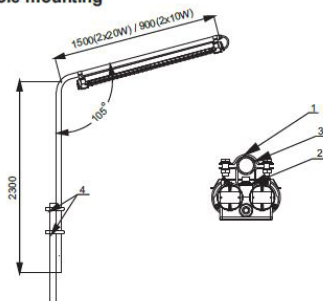
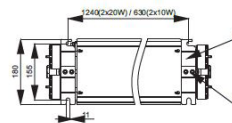
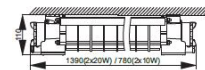
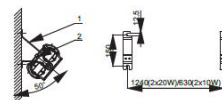

Diagram of BC5401

Ceiling mounting



Side wall mounting



Ceiling mounting 2

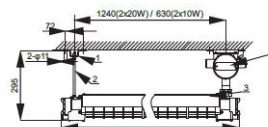

The Tormin BC5401 is covered by our 5 Year repair/replace Warranty. Warranty upgrade packages available. UK purchases, warranty handled through Carbon8Lighting.

www.carbon8lighting.co.uk
01256 300031
sales@c8l.co.uk

CARBON8
LIGHTING

